

bFRIENDS

Nachhaltige Designaccessories sorgen im Handumdrehen für Ordnung und bringen eine inspirierende Atmosphäre in jede Umgebung. Diesen Anspruch erfüllt bFRIENDS, die innovative Accessoire-Kollektion für den Wohn- und Arbeitsbereich, die in Partnerschaft mit dem Design Team von Pearson Lloyd entwickelt wurde. Bereits gebrauchte Verpackungsmaterialien aus pflanzlichem Kunststoff werden recycelt, zu neuem Filament verarbeitet und im 3D Druck entstehen daraus die Produkte der bFRIENDS Kollektion.

Design: Pearson Lloyd

Die Produktpalette umfasst zahlreiche Artikel: unterschiedliche Aufbewahrungsbehälter wie Pots, Trays und Boxes, vielseitig einsetzbaren Stands, Dekorationsartikel, Vasen und Pflanzgefäße, sowie flexible Haken und Clips. Die bFRIENDS sind in unterschiedlichen Größen verfügbar und zeichnen sich durch ihre vielseitige Funktionsweise aus – in ihrem Einsatz sind den Möglichkeiten keine Grenzen gesetzt.



PRODUKTBESCHREIBUNG & DIMENSIONEN

3D gedruckte Accessoires-Kollektion aus biobasiertem Kunststoff (PLA). Das Ausgangsmaterial wird aus mechanisch recyceltem PLA hergestellt, das biologisch abbaubar und recyklierbar ist.

HINWEISE

- PLA wird über 50 °C formbar und weich. Die Teile sind daher nicht für die Reinigung in der Spülmaschine geeignet.
- Durch das FDM-3D-Druckverfahren entsteht eine Rillenstruktur an der Oberfläche der Elemente. Es können darüber hinaus verfahrensbedingt Unregelmäßigkeiten in der Oberflächenstruktur entstehen. Diese stellen keinen Reklamationsgrund dar.

ORGANISERS

Whiteboard Pot

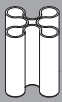

B: 76
 T: 76
 H: 82

Pen Pot

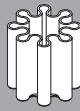

B: 82
 T: 82
 H: 82

Duo Pot



B: 64
 T: 128
 H: 82

Trio Pot

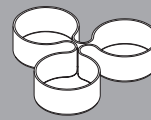

B: 165
 T: 152
 H: 35

Pen Tray

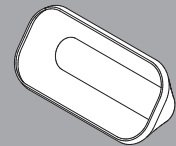

B: 100
 T: 210
 H: 51

Desk Pots



B: 130
 T: 177
 H: 109

Coin Bank



B: 119
 T: 119
 H: 99

Coin Collector



B: 32
 T: 175
 H: 60

Tilted Set

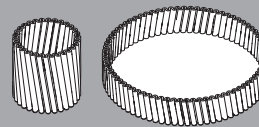

B: 80 / 195
 T: 80 / 195
 H: 82 / 35

Tilted Tray

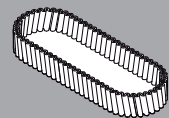

B: 80
 T: 220
 H: 32

Tray S

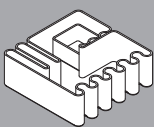

B: 128
 T: 128
 H: 45

Tray M

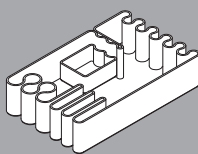

B: 128
 T: 205
 H: 45

Tray L

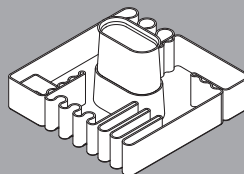

B: 205
 T: 205
 H: 105

Tidy Box

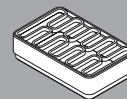

B: 66
 T: 105
 H: 28

Cable Box



B: 80
 T: 80
 H: 28

Stand XS

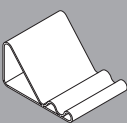

B: 82
 T: 105
 H: 57

Stand S

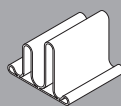

B: 82
 T: 92
 H: 69

Stand M

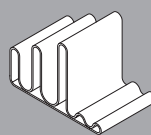

B: 82
 T: 137
 H: 91

Stand L

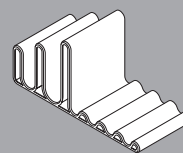

B: 82
 T: 189
 H: 91

Stand XL

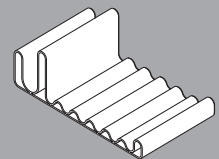

B: 120
 T: 211
 H: 69

Maße in mm

Bookend

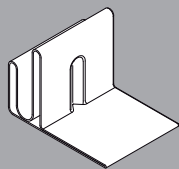

B: 120
 T: 161
 H: 111

Magazine Rack

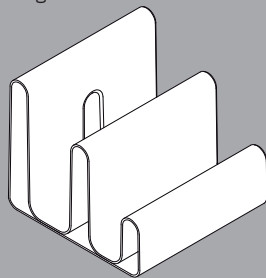

B: 210
 T: 216
 H: 190

HANGERS, HOOKS & CLIPS

Screen Hook 19



für 19 mm

B: 45
 T: 76
 H: 85

Screen Hook 38

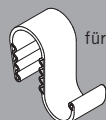

für 38 mm

B: 45
 T: 91
 H: 93

Screen Hook 50

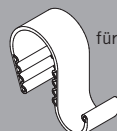

für 50 mm

B: 45
 T: 102
 H: 110

Screen Clip 19



für 19 mm

B: 45
 T: 47
 H: 68

Screen Clip 38



für 38 mm

B: 45
 T: 60
 H: 72

Table Hook 13



für 13 mm

B: 45
 T: 68
 H: 65

Table Hook 16



für 16 mm

B: 45
 T: 69
 H: 67

Table Hook 19



für 19 mm

B: 45
 T: 69
 H: 71

Table Hook 25



für 25 mm

B: 45
 T: 71
 H: 77

Pizza Clip



B: 30
 T: 37
 H: 54

Coat Stand

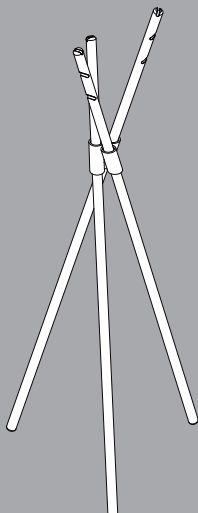

B: 575
 T: 556
 H: 1.691

Wall Hooks

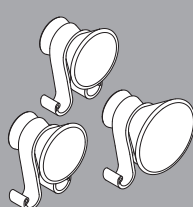

B: 80 / 100
 T: 72 / 86
 H: 124 / 134

Maße in mm

DECORATION

Wildlife Collection

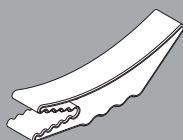

Crocodile
 B: 33
 T: 186
 H: 49

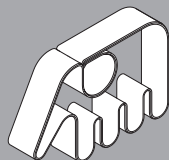

Elephant
 B: 33
 T: 170
 H: 110



Bird
 B: 20
 T: 86
 H: 45

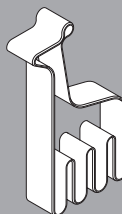

Giraffe
 B: 33
 T: 117
 H: 199

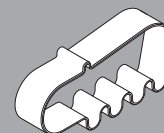

Hippo
 B: 33
 T: 162
 H: 76

Aquatic Collection



Penguin
 B: 33
 T: 67
 H: 123

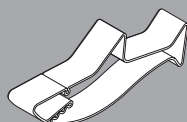

Shark
 B: 33
 T: 197
 H: 71

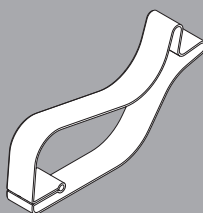

Whale
 B: 33
 T: 221
 H: 119



Seal
 B: 33
 T: 156
 H: 103



Fish
 B: 20
 T: 71
 H: 54

The Town Musicians

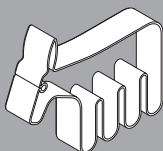

Donkey
 B: 33
 T: 176
 H: 152

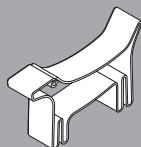

Dog
 B: 33
 T: 146
 H: 90

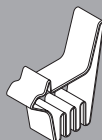

Cat
 B: 33
 T: 97
 H: 110



Rooster
 B: 20
 T: 60
 H: 59

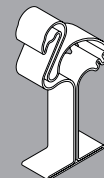

Flamingo / Flamingo Big
 B: 33 / 48
 T: 60 / 239
 H: 169 / 450

Desert Collection

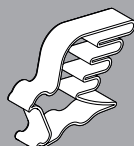

Falcon
 B: 22
 T: 110
 H: 81

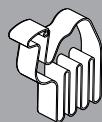

Camel
 B: 33
 T: 134
 H: 148

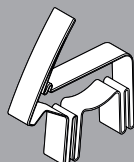

Oryx
 B: 33
 T: 173
 H: 199



Love Birds
 B: 22
 T: 90
 H: 68

Maße in mm

Xmas Collection

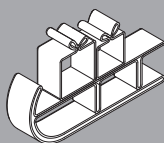

Sleigh with presents
 B: 33 / 33 / 33
 T: 190 / 50 / 40
 H: 82 / 66 / 56

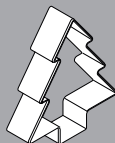

Xmas Tree
 B: 33
 T: 127
 H: 147



Star
 B: 33
 T: 92
 H: 90

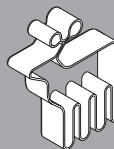

Reindeer
 B: 33
 T: 134
 H: 156



Snowman
 B: 33
 T: 85
 H: 140

Xmas Ornaments



Snowflake
 B: 8
 T: 94
 H: 107



Candy Cane
 B: 8
 T: 44
 H: 125



Stocking
 B: 8
 T: 63
 H: 108



Present
 B: 8
 T: 63
 H: 90



Bell
 B: 8
 T: 85
 H: 88



Ornament Star
 B: 8
 T: 102
 H: 120

Number 0

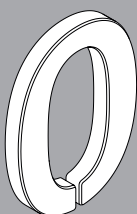

B: 15
 T: 120
 H: 160

Number 1

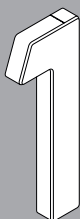

B: 15
 T: 57
 H: 160

Number 2



B: 15
 T: 115
 H: 160

Number 3



B: 15
 T: 123
 H: 160

Number 4



B: 15
 T: 108
 H: 160

Number 5



B: 15
 T: 124
 H: 160

Number 6



B: 15
 T: 119
 H: 160

Number 7

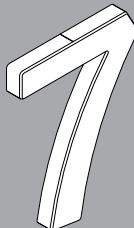

B: 15
 T: 120
 H: 160

Number 8



B: 15
 T: 126
 H: 160

Number 9



B: 15
 T: 119
 H: 160

Maße in mm

VASES & PLANT POTS

Vases 3

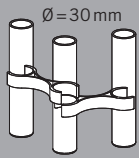

B: 38
 T: 166
 H: 150

Vases 5

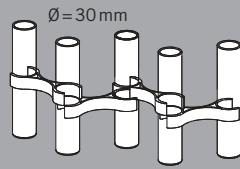

B: 38
 T: 296
 H: 150

Big Vases 3

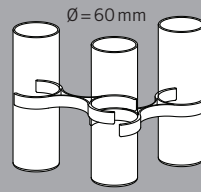

B: 65
 T: 278
 H: 185

Vases Mix 5

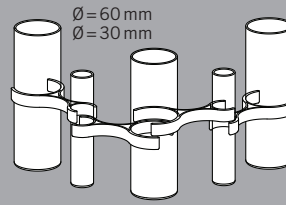

B: 65
 T: 420
 H: 185

Plant Pots

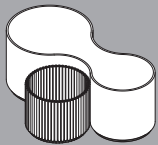

B: 143
 T: 207
 H: 73

Plant Pots L

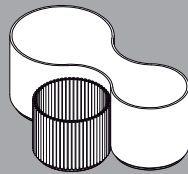

B: 182
 T: 275
 H: 98

Tilted Plant Pot L



B: 200
 T: 200
 H: 172

Maße in mm

ANWENDUNGSBEISPIELE

ORGANISERS

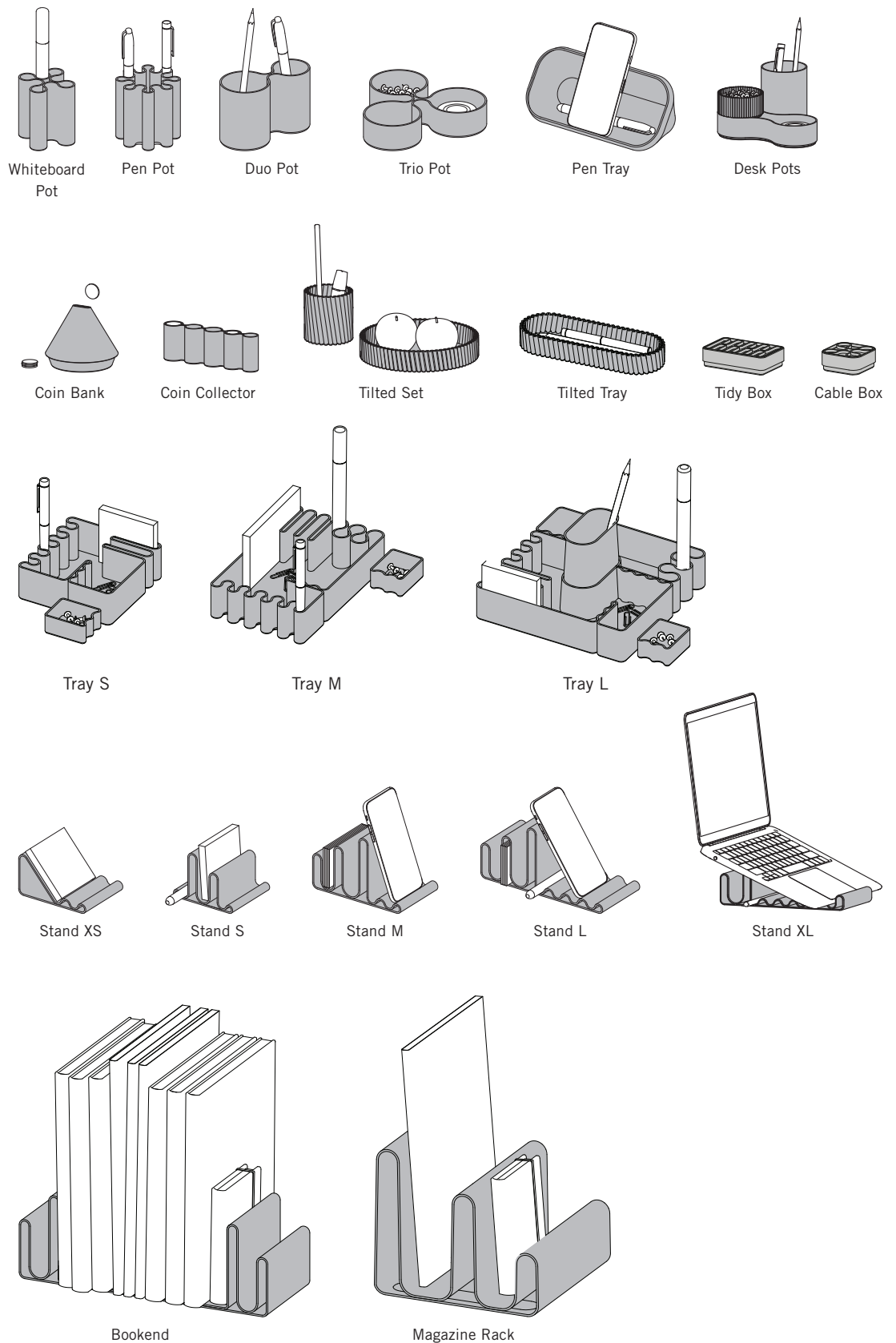

ANWENDUNGSBEISPIELE

HANGERS, HOOKS & CLIPS

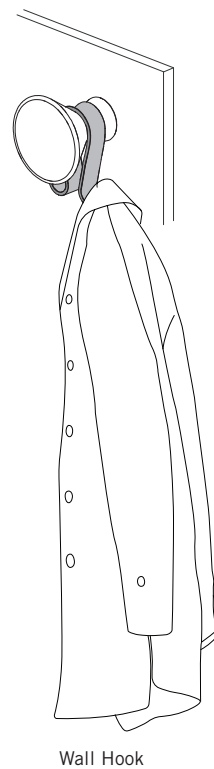
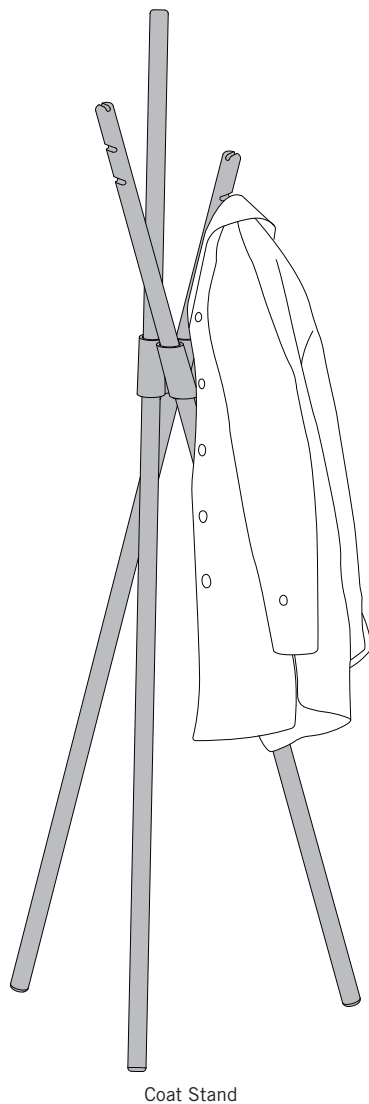
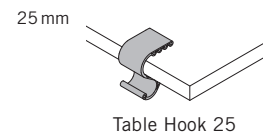
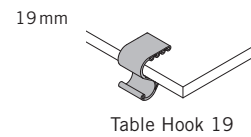
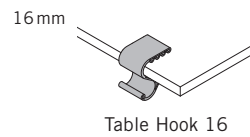
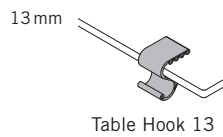
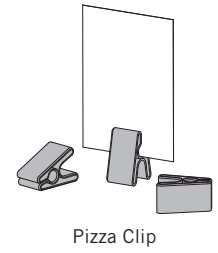
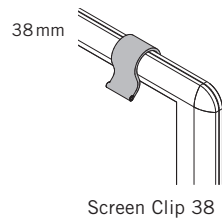
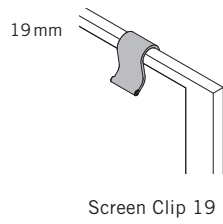
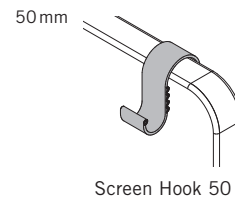
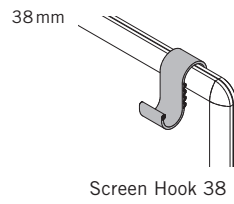
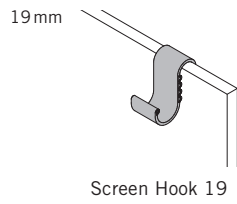

ANWENDUNGSBEISPIELE

DECORATION

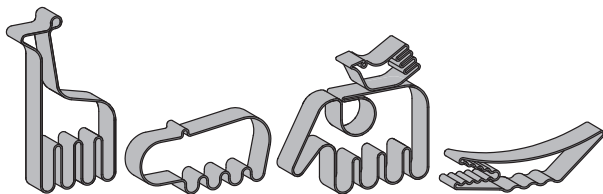

Wildlife Collection

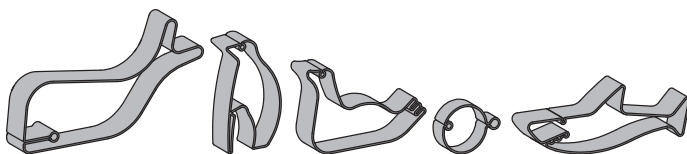

Aquatic Collection

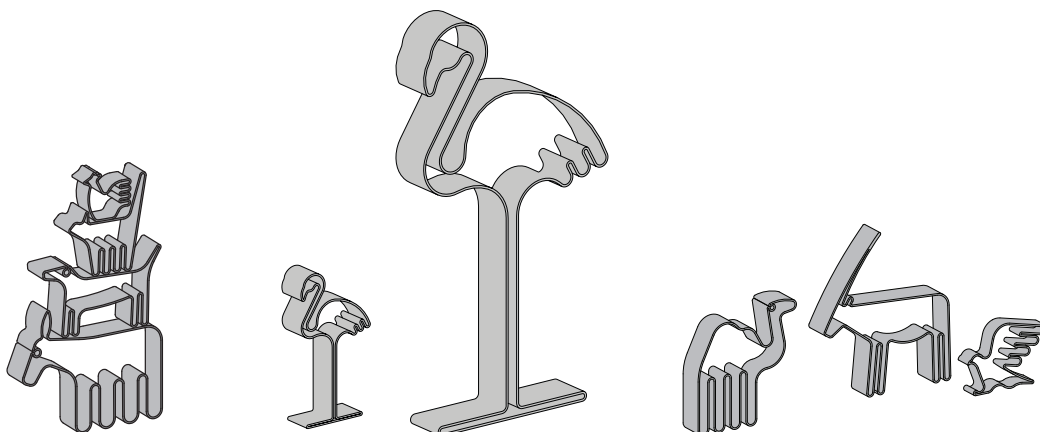

The Town Musicians

Flamingo + Flamingo Big

Desert Collection

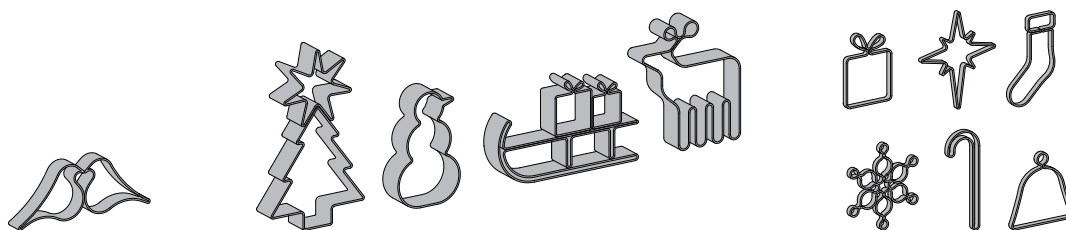

Love Birds

Xmas Collection

Xmas Ornaments

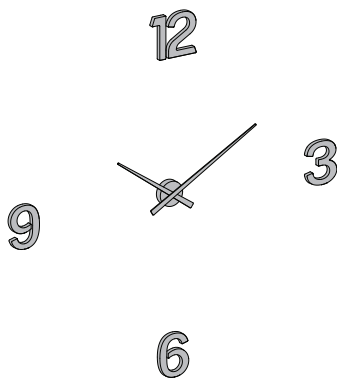

Wall Clock Set 3-6-9-12

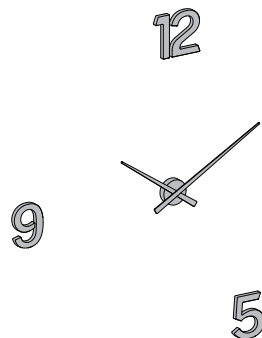

Wall Clock Set 5-9-12

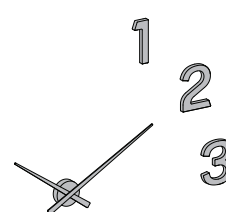

Wall Clock Set 1-2-3

ANWENDUNGSBEISPIELE

VASES & PLANT POTS

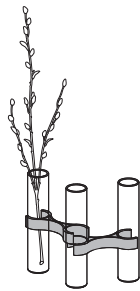

Vases 3

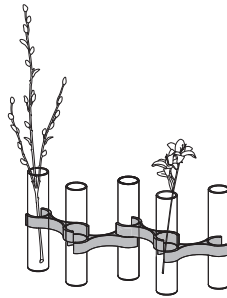

Vases 5

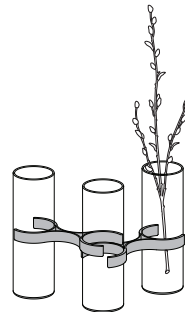

Big Vases 3

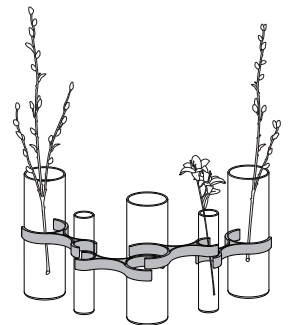

Vases Mix 5

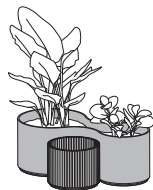

Plant Pots

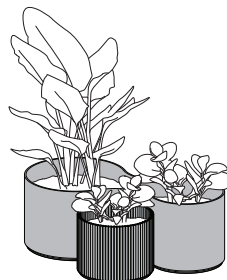

Plant Pots L

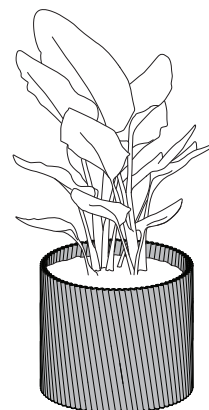

Tilted Plant Pot L

FARBKONFIGURATIONEN

Folgende bFRIENDS gibt es in vordefinierten Farben oder Farbkombinationen.

ORGANISERS

Coin Bank

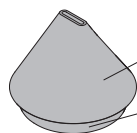

Farbe 1

Farbe 2

Tidy Box

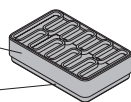

Cable Box



Farbe 1

Farbe 2

Farbe 1



Soft blue



Clay



Navy



Ochre



Wild sage



Light grey

Farbe 2



Raspberry



Anthracite



Soft blue



Terracotta



Green



Soft blue

Tray S, M und L

Die Trays sind mit einem Pin Pot für kleine Einzelteile ausgestattet, das Tray L zusätzlich mit einem mittigen Vessel.

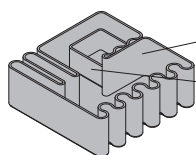

Farbe 1

Farbe 2

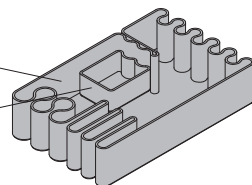

Farbe 1

Farbe 2

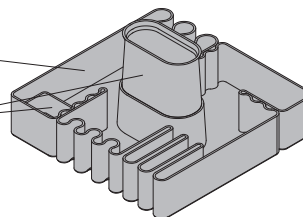

Farbe 1



Clay



Light grey



Wild sage



Green



Anthracite



Apricot



Pearl



Soft blue



Navy



Ochre



Terracotta



Plum



Raspberry

Farbe 2



Anthracite



Soft blue



Green



Wild sage



Clay



Raspberry



Plum



Raspberry



Soft blue



Terracotta



Ochre



Pearl



Soft blue

FARBKONFIGURATIONEN

DECORATION

Alle Teile der gezeigten Kollektionen sind jeweils im Set oder einzeln erhältlich. Jedes Set besteht aus vordefinierten Farben, wie unten dargestellt. Werden die Dekorationselemente einzeln bestellt, sind sie in allen Farben der bFRIENDS Standardkollektion verfügbar.

Wildlife Collection

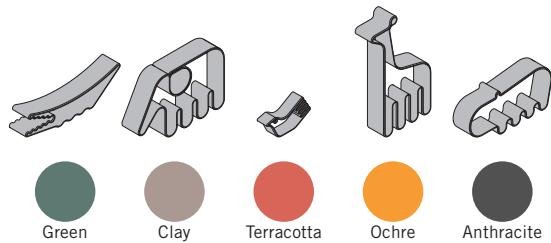

Aquatic Collection

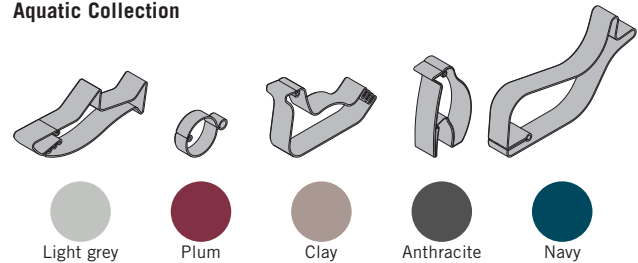

The Town Musicians

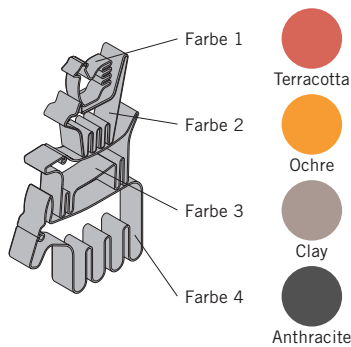

Desert Collection

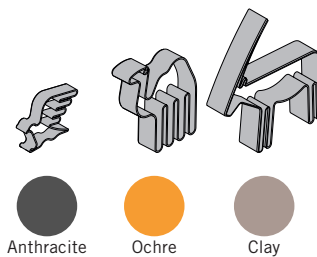

Love Birds

Ein Set besteht aus zwei Love Birds. Diese sind wahlweise in der gleichen Farbe, oder in zwei verschiedenen, vordefinierten Farben erhältlich.

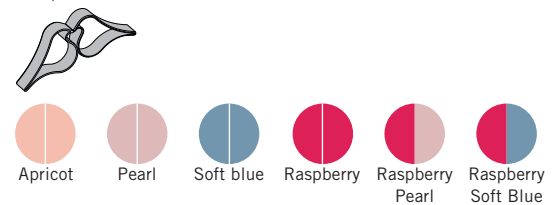

Xmas Collection

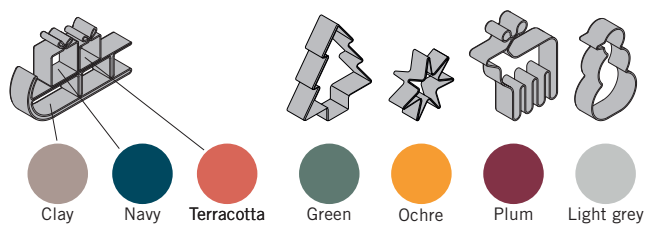

Xmas Ornaments

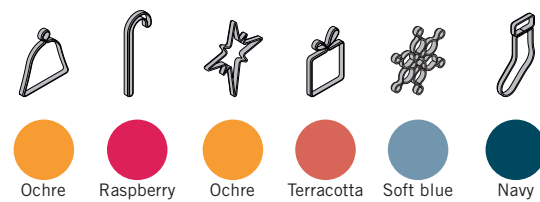

Wall Clocks

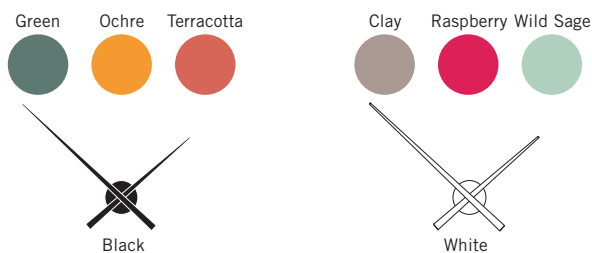

Das Uhrwerk der Wall Clock kann in Black oder White gewählt werden. Dazupassend gibt es jeweils drei vordefinierte Farben für die Zahlen. Optional sind die Zahlen aber auch in allen Farben der bFRIENDS Standardkollektion verfügbar.

PRODUKTBESCHREIBUNG BFRIENDS POWER MODULE

Das bFRIENDS Power Module ist in drei Größen verfügbar - S, M und L.

Die Montage kann bei allen Tischen überall dort erfolgen wo ein Kabelausslass möglich ist. Außerdem kann auch eine bestehende Kabelausslassbohrung (Durchmesser 80 mm) um ein Power Module erweitert werden. Nicht möglich in Kombination mit einer Schiebeplatte.

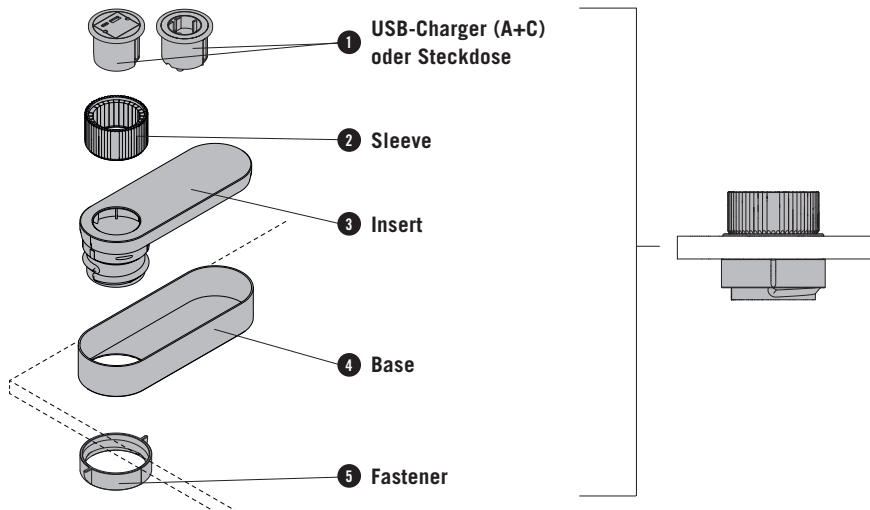

BFRIENDS POWER MODULE TYPEN

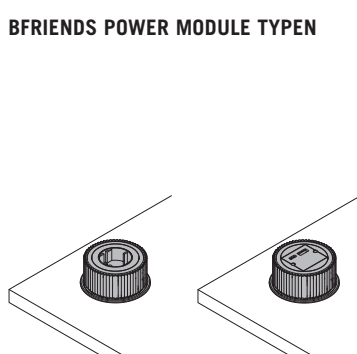

Typ S
 mit Steckdose oder USB-Charger (A+C)
 Ladebuchse USB-A 18W / USB-C 22W

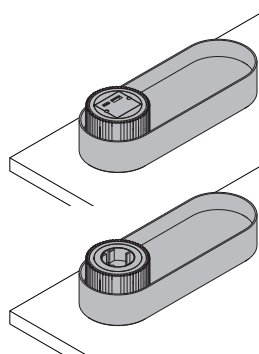

Typ M
 mit Steckdose oder USB-Charger (A+C)
 Ladebuchse USB-A 18W / USB-C 22W

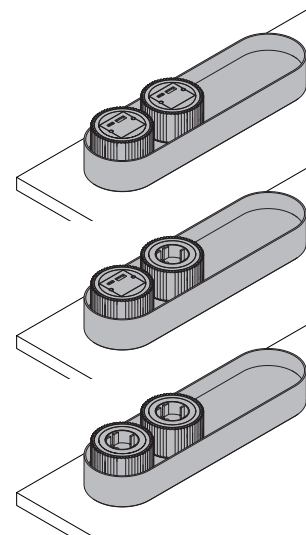

Typ L
 mit Steckdose und/oder USB-Charger (A+C)
 Ladebuchse USB-A 18W / USB-C 22W
 (möglich sind: 2x Steckdose | 2x USB |
 1x Steckdose + 1x USB)

DIMENSIONEN BFRIENDS POWER MODULE

BFRIENDS POWER MODULES bFRIENDS Power Module S	bFRIENDS Power Module M	bFRIENDS Power Module L
B: 86 T: 86 H: 36/87	B: 268 T: 92 H: 67/118	B: 348 T: 92 H: 67/118

Maße in mm

FARBKONFIGURATIONEN

BFRIENDS POWER MODULE S, M UND L

Die bFRIENDS Power Modules gibt es in den unten dargestellten Farben. Farbe 1 und Farbe 2 können in der gleichen Farbe oder verschiedenfarbig beliebig kombiniert werden. Der Fastener ist immer in Anthracite ausgeführt.

Typ S

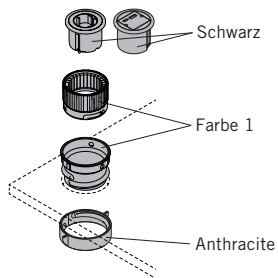

Typ M

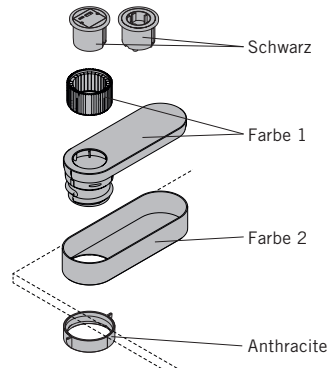

Typ L

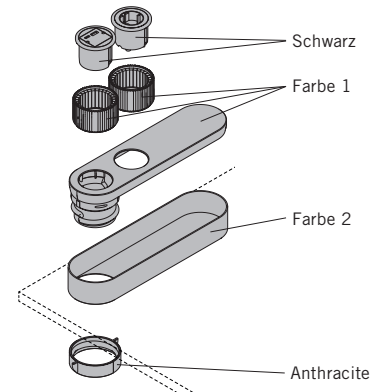

Lieferinformation

Folgende Farbkombination sind auf Lager und kurzfristig verfügbar:

bFRIENDS Power Module S: Anthracite
Green

bFRIENDS Power Module M+L: Farbe 1 Anthracite + Farbe 2 Light Grey
Farbe 1 Anthracite + Farbe 2 Green

Alle anderen Farbvarianten benötigen eine längere Lieferzeit.

Verkabelung

Es ist erforderlich, eine Anfangs- oder Verbindungsleitung mit der gewünschten Länge zu konfigurieren.

FARBEN & MATERIALIEN



Clay



Light grey



Wild sage



Green



Anthracite



Apricot



Pearl



Soft blue



Navy



Ochre



Terracotta



Plum



Raspberry



Vibrant Yellow¹



Light Orange¹



Pink¹

¹ Sonderedition ausschließlich für Flamingo und Flamingo Big, nur bestellbar solange der Vorrat reicht

HOLZ (ESCHE)

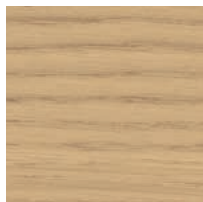

Natural

KUNSTSTOFF



Vulcano

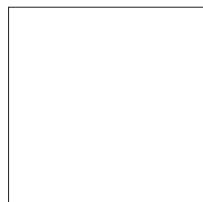

White



Black

GLAS

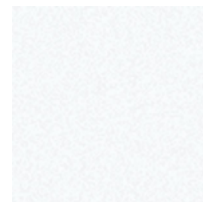

Clear glass

DIE BENE VERANTWORTUNG

Bene nimmt eine Vorreiterrolle im Bereich der Nachhaltigkeit ein. Dies umfasst alle Unternehmensbereiche – von der Produktentwicklung, -beschaffung, Produktion und Logistik bis hin zur Produktverwertung. Von der ersten Skizze bis zur Serienreife fließen immer ökologische Anforderungen in den Produktentwicklungsprozess ein. Dazu gehören die Auswahl umweltverträglicher Materialien wie zum Beispiel zertifizierte Hölzer aus nachhaltig bewirtschafteten Forstbeständen, die Verwendung von Recyclingwerkstoffen oder der verstärkte Einsatz nachwachsender Rohstoffe. Materialkennzeichnung, Reparierbarkeit und eine lange Lebensdauer der eingesetzten Komponenten sind ebenfalls wichtige Anforderungen an das Produktdesign, damit diese einem zweiten Produkt-Lebenszyklus zugeführt werden können. Um am Ende der Lebensdauer eine hohe Recyclingfähigkeit unserer Produkte zu garantieren, verzichten wir so weit wie möglich auf Verbundmaterialien und entwickeln sortenrein zerlegbare Möbel. 99,9% aller Lieferungen erreichen uns aus einem europäischen Land. Rund 94% aller Rohstofflieferungen stammen aus Österreich und Deutschland. Rund 93% der Rohstoffe werden von Lieferanten mit Sitz im Umkreis von 500km zu unserem Produktionsstandort geliefert.

NACHHALTIGE ROHSTOFFE

Für Bene ist der Einsatz folgender Komponenten selbstverständlich:

- formaldehydarme Spanplatten
- formaldehydarme Leime
- Wasserlacksysteme
- recyclingfähige Stoffe
- Materialien mit hohen Recyclinganteilen
- PVC-freie Kunststoffe

Bene garantiert, dass seine Produkte frei sind von:

- CMR-Stoffen
- halogenierten Lösungsmitteln in Kunststoffen
- chlorierten Kohlenwasserstoffen
- Schwermetallpigmenten
- Materialien mit Azo-Farbstoffen
- Beschichtungen mit biozider Wirkung (zum Beispiel Holzschutzmittel, Pestizide)

BEITRAG ZU GEBÄUDEZERTIFIZIERUNGEN

Im Rahmen der ökologischen Gebäudezertifizierung tragen auch Einrichtungssysteme wie Möbel und Trennwände zur Erreichung eines guten Ergebnisses bzw. einer höheren Punktzahl bei.

Die Produkte von Bene können einen Beitrag zu LEED, WELL Building Standard, DGNB, BREEAM etc. leisten. Kriterien sind beispielsweise Umweltproduktdeklarationen, Innenraumluftqualität, Akustik und Umnutzungsfähigkeit.

BFRIENDS

Beispielkonfiguration

- Tray S
- Gesamtgewicht 0,12 kg

Ökologische Kennzahlen

- 100% sortenreine Trennbarkeit
- 100% Recyclefähigkeit
- 100% Anteil an nachwachsenden Rohstoffen
- 98,5% Verwendung von recycelten Produktionsmaterialien

Materialien

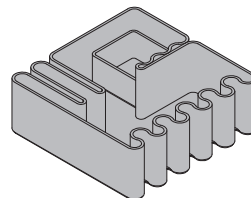
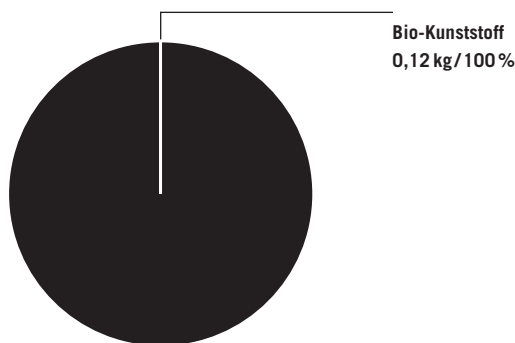

Auf Wunsch können für jede Standard-Produktkonfiguration Umwelt-Produktdeklarationen (EPD, LCA), bei Bene Life Cycle Data Sheets genannt, zur Verfügung gestellt werden.

Eine Auflistung der produktspezifischen Zertifikate und Designauszeichnungen finden Sie auf der Bene Produkt-Website.

Umweltinformationen Bene: <https://bene.com/de/bene/nachhaltigkeit/nachhaltigkeitsbericht-2021>