



MOVE IT PRO system

trimless

EN Extruded aluminium profile with 45 mm width and 55 mm height; for trimless installation in 12.5 mm plasterboard ceilings; designed for continuous lighting systems, L / T / X connectors for flexible system design; with integrated 3-phase copper conductors + 4 emergency lighting copper conductors (2 emergency lighting circuits) + 2 DALI copper conductors for take off of supply voltage, emergency lighting power supply and DALI signal; customcut possible; surface powder coated; insets, incl. high power adapter + converter can be installed flexibly and without tools; light inserts with different patterns of light distribution, emergency light inserts (escape sign and emergency luminaires) for operation on a central battery system and sensor inserts can be integrated

DE Aluminiumstrangpressprofil mit 45 mm Breite und 55 mm Höhe; für randlosen Einbau in 12,5 mm Gipskartondecken; ausgelegt für durchgehende Lichtsysteme, L- / T- / X-Verbinder für flexiblen Systemaufbau; mit integrierten 3-Phasen Kupferleitern + 4 Notlicht-Kupferleitern (2 Notlichtkreise) + 2 DALI-Kupferleitern für Abnahme von Versorgungsspannung, Notlicht-Spannungsversorgung und DALI Signal; auf Kundenwunsch ablängbar; Oberfläche pulverbeschichtet; flexible und werkzeuglose Montage der Einsätze, inkl. High Power Adapter + Konverter; Leuchteinsätze mit unterschiedlichen Abstrahlcharakteristiken, Notlichteinsätze (Rettungszeichen- und Sicherheitsleuchten) für den Betrieb an einer Zentralbatterieanlage und Sensor-Einsätze integrierbar

Quickinfo

DALI-2

Types

recessed
trimless

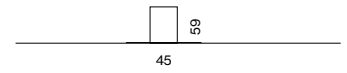

connectors



L-connector

T-connector

X-connector

Colours



up to 192lm/W
(high efficiency)

Order options

CONTROL

DALI-2

MATERIAL COLOUR

- jet black RAL 9005 8
- traffic white RAL 9016 7



MOVE IT PRO trimless

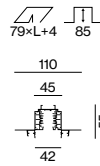

INSTALLATION TRACK 220 V – 250 V / 440 V | EM 220 V – 250 V

L (mm)		ORDER CODE
1000	channel	086-512113 <input checked="" type="checkbox"/>
2000	channel	086-512213 <input checked="" type="checkbox"/>
3000	channel	086-512313 <input checked="" type="checkbox"/>
4000	channel	086-512413 <input checked="" type="checkbox"/>
custom cut	channel	E83810 ···· <input checked="" type="checkbox"/>

Pole options

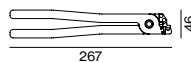
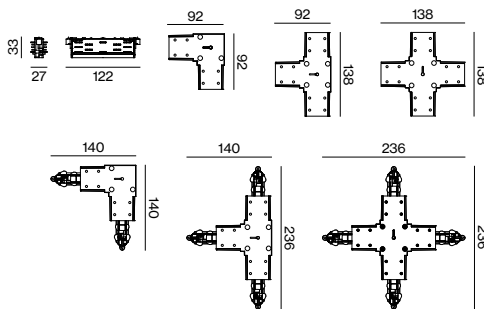
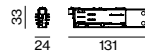
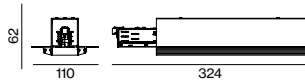
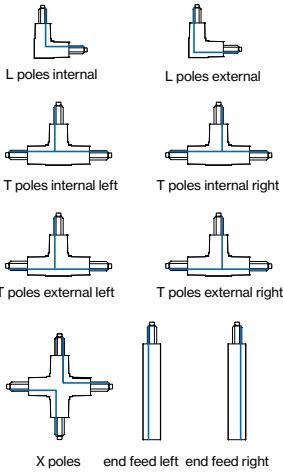

Accessories

END CAPS

TYPE	ORDER CODE
end cap	086-522011 <input checked="" type="checkbox"/>

BLIND COVER

L (mm)		ORDER CODE
25000	blind cover	086-608250 <input checked="" type="checkbox"/> B

POWER FEEDER WITH EMERGENCY CONDUCTORS

supply 220-240 V AC, 48 V, 50-60 Hz

TYPE	ORDER CODE
end feed poles right	086-522313 <input checked="" type="checkbox"/>
end feed poles left	086-522413 <input checked="" type="checkbox"/>
middle feed	086-522323 <input checked="" type="checkbox"/>

POWER FEEDER WITHOUT EMERGENCY CONDUCTORS

supply 220-240 V AC, 48 V, 50-60 Hz

TYPE	ORDER CODE
intrack feed	086-5213338

CONNECTORS

TYPE	ORDER CODE
linear connector electrical	086-5211138
L-connector poles external	086-522133 <input checked="" type="checkbox"/>
L-connector poles internal	086-522233 <input checked="" type="checkbox"/>
L-connector mechanical	086-522230 <input checked="" type="checkbox"/>
T-connector poles internal right	086-522143 <input checked="" type="checkbox"/>
T-connector poles internal left	086-522243 <input checked="" type="checkbox"/>
T-connector poles external right	086-522173 <input checked="" type="checkbox"/>
T-connector poles external left	086-522273 <input checked="" type="checkbox"/>
T-connector (mechanical)	086-522240 <input checked="" type="checkbox"/>
X-connector	086-522153 <input checked="" type="checkbox"/>
X-connector (mechanical)	086-522150 <input checked="" type="checkbox"/>

MOUNTING ACCESSORIES

TYPE	ORDER CODE
mechanical linear connector (pair)	050-2011110
conductors cutting tool	086-5219110

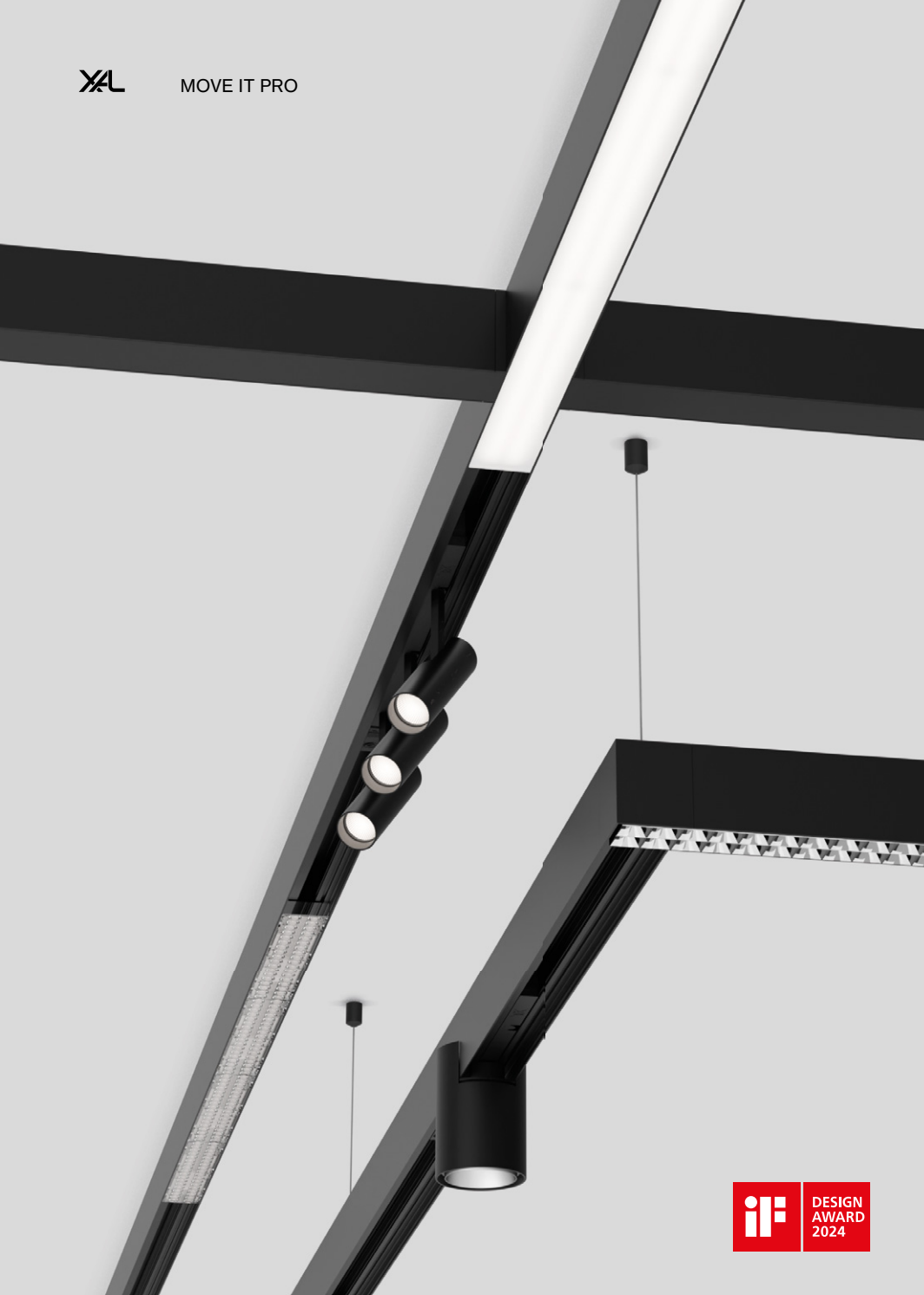

MOVE IT PRO system

surface/suspended

EN Extruded aluminium profile with 45 mm width and 59 mm height; for ceiling surface mounting or suspended mounting (cable suspension); height adjustment without tools; designed for continuous lighting systems, L / T / X connectors for flexible system design; with integrated 3-phase copper conductors + 4 emergency lighting copper conductors (2 emergency lighting circuits) + 2 DALI copper conductors for take off of supply voltage, emergency lighting power supply and DALI signal; customcut possible; surface powder coated; insets, incl. high power adapter + converter can be installed flexibly and without tools; light inserts with different patterns of light distribution, emergency light inserts (escape sign and emergency luminaires) for operation on a central battery system and sensor inserts can be integrated

DE Aluminiumstrangpressprofil mit 45 mm Breite und 59 mm Höhe; für Deckenanbaumontage oder für abgehängte Montage (Seilabhängung); werkzeuglose Höhenverstellung; ausgelegt für durchgehende Lichtsysteme, L- / T- / X-Verbinder für flexiblen Systemaufbau; mit integrierten 3-Phasen Kupferleitern + 4 Notlicht-Kupferleitern (2 Notlichtkreise) + 2 DALI-Kupferleitern für Abnahme von Versorgungsspannung, Notlicht-Spannungsversorgung und DALI Signal; auf Kundenwunsch ablängbar; Oberfläche pulverbeschichtet; flexible und werkzeuglose Montage der Einsätze, inkl. High Power Adapter + Konverter; Lichteinsätze mit unterschiedlichen Abstrahlcharakteristiken, Notlichteinsätze (Rettungszeichen- und Sicherheitsleuchten) für den Betrieb an einer Zentralbatterieanlage und Sensor-Einsätze integrierbar

Quickinfo

DALI-2

Types

surface suspended

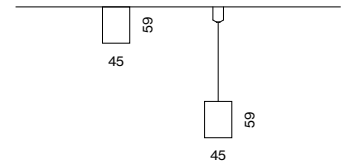

connectors



L-connector

T-connector

X-connector

Colours



up to 192 lm/W
(high efficiency)

Order options

CONTROL

DALI-2

MATERIAL COLOUR

- jet black RAL 9005 8
- traffic white RAL 9016 7

MATERIAL COLOUR

CABLE SUSPENSION

- black 8
- chrome 0



MOVE IT PRO surface/suspended



INSTALLATION TRACK 220V-250V/440V | EM 220V-250V

L (mm)	TYPE	ORDER CODE
1000	channel	086-511113
2000	channel	086-511213
3000	channel	086-511313
4000	channel	086-511413
custom cut	channel	E83820

Accessories

END CAPS

TYPE	ORDER CODE
end cap	086-521011

BLIND COVER

L (mm)	TYPE	ORDER CODE
25000	blind cover	086-608250

POWER FEEDER WITH EMERGENCY CONDUCTORS

supply 220-240V AC, 48V, 50-60Hz

TYPE	ORDER CODE
end feed poles right	086-521413
end feed poles left	086-521313
middle feed	086-521323

POWER FEEDER WITHOUT EMERGENCY CONDUCTORS

supply 220-240V AC, 48V, 50-60Hz

TYPE	ORDER CODE
intrack feed	086-5213338

Pole options

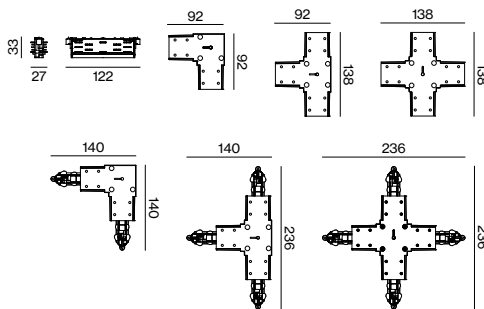
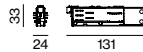
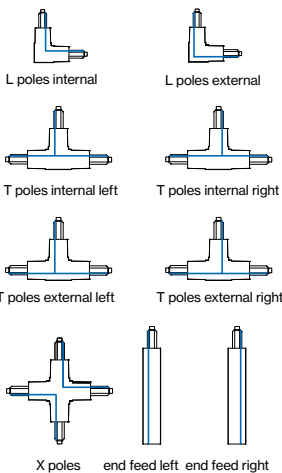

CONNECTORS

TYPE	ORDER CODE
linear connector electrical	086-5211138
L-connector poles external	086-521133
L-connector poles internal	086-521233
L-connector mechanical	086-521230
T-connector poles internal right	086-521143
T-connector poles internal left	086-521243
T-connector poles external right	086-521173
T-connector poles external left	086-521273
T-connector (mechanical)	086-521240
X-connector	086-521153
X-connector (mechanical)	086-521150

MOUNTING ACCESSORIES

TYPE	ORDER CODE
ceiling fastener	086-521511
suspension bracket	086-521521
linear suspension connector (mechanical)	086-521531
conductors cutting tool	086-5219110
drilling template for indirect inset	086-5219510

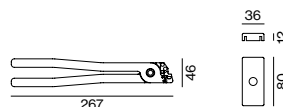
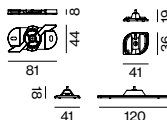

CABLE SUSPENSION

TYPE	L (mm)	ORDER CODE
cable suspension	1500	086-521711
cable suspension	3000	086-521721
cable suspension	6000	086-521731
connector cable suspension	1500	058-301811
connector cable suspension	3000	058-301821
connector cable suspension	6000	058-301831
tool for connector cable suspension		050-2049210

Quickinfo

2700 K, 3000 K, 3500 K, 4000 K
 CRI \geq 80, CRI \geq 90, 3 SDCM
 UGR \leq 19 / 65° \leq 1500 cd/m²
 up to 187 lm/W
 up to 2940 lm/m
 L90 @ 50 000 h
 DALI-2

Types

louver

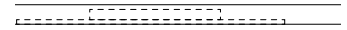

Colours



Light distribution



super
wide
flood



LOUVER

linear inset

^{EN} Linear light inset made of plastic; light inset, incl. high power adapter + converter can be installed flexibly and without tools; flush with profile system; high quality reflector with micro-faceted, aluminum-vaporised surface; precise radiation characteristic with symmetrical light distribution; for use in schools and offices; energy-efficient LEDs with very good colour rendering

^{DE} Linear-Lichteinsatz aus Kunststoff; Lichteinsatz, inkl. High Power Adapter + Konverter, werkzeuglos einsetz- und verschiebbar; bündig im Profilsystem; hochwertiger Reflektor mit mikrofaccettierter, aluminiumbedampfter Oberfläche; präzise Abstrahlcharakteristik mit symmetrischer Lichtverteilung; für den Einsatz in Schulen und im Bürobereich; energieeffiziente LEDs mit sehr guter Farbwiedergabe

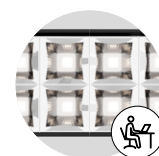

DIN EN 12464-1
UGR \leq 19



up to 187 lm/W
(high efficiency)

Order options

COLOUR TEMPERATURE

2700K CRI ≥ 90	9
3000K CRI ≥ 90	0
3500K CRI ≥ 90	2
4000K CRI ≥ 90	1
2700K CRI ≥ 80	4
3000K CRI ≥ 80	5
3500K CRI ≥ 80	7
4000K CRI ≥ 80	6

CONTROL

DALI-2

LIGHT OPTIC

super wide flood 74°

MATERIAL COLOUR

chrome reflector	4
black reflector	8

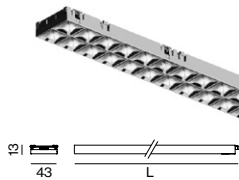

LOUVER inset



REFLECTOR WIDE

SYSTEM POWER	COLOUR TEMP.	LUM. FLUX	L (mm)	ORDER CODE
16.7W	2700K	2580lm	1000	0 8 6 - 6 4 1 0 :: 3 X
	3000K	2580lm		
	3500K	2760lm		
	4000K	2940lm		
25.1W	2700K	3870lm	1500	0 8 6 - 6 4 2 0 :: 3 X
	3000K	3870lm		
	3500K	4140lm		
	4000K	4400lm		
33W	2700K	5160lm	2000	0 8 6 - 6 4 3 0 :: 3 X
	3000K	5160lm		
	3500K	5520lm		
	4000K	5870lm		
42W	2700K	6450lm	2500	0 8 6 - 6 4 4 0 :: 3 X
	3000K	6450lm		
	3500K	6890lm		
	4000K	7340lm		
47W	2700K	7740lm	3000	0 8 6 - 6 4 5 0 :: 3 X
	3000K	7740lm		
	3500K	8270lm		
	4000K	8810lm		

Quickinfo

2700 K, 3000 K, 3500 K, 4000 K
 CRI ≥ 80, CRI ≥ 90, 3 SDCM
 up to 162 lm/W
 up to 4960 lm/m
 L90 @ 50 000 h
 DALI-2

Types

shelf floor washer

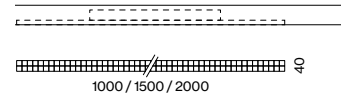

wallwasher

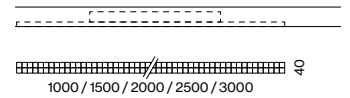

Colours



Light distributions



shelf floor washer 1-sided
 shelf floor washer 2-sided
 wall washer 1-sided



SHELF FLOOR WASHER

linear inset

EN Linear light inset made of plastic; light inset, incl. high power adapter + converter can be installed flexibly and without tools; flush with profile system; high quality reflector with micro-faceted, aluminum-vaporised surface; with special, multi-free-form, facet effect surface reflectors for high precision light control; precise shelf and aisle zone lighting, optimum longitudinal glare control for high viewing comfort in the aisle zone; for use in grocery and fashion; energy-efficient LEDs with very good colour rendering

DE Linear-Lichteinsatz aus Kunststoff; Lichteinsatz, inkl. High Power Adapter + Konverter, werkzeuglos einsetz- und verschiebbar; bündig im Profilsystem; hochwertiger Reflektor mit mikrofaccettierter, aluminiumbedampfter Oberfläche; mit speziellen Multi-Freiformflächenreflektoren mit Facettenoptik zur äußerst präzisen Lichtlenkung; punktgenaue Regal- und Gangzonenausleuchtung, optimale Längsentblendung für hohen Sehkomfort in der Gangzone; für den Einsatz im Lebensmittelhandel und Fashionbereich; energieeffiziente LEDs mit sehr guter Farbwiedergabe



glare-free reflector
longitudinally



precision
cut-off



up to 162 lm/W
(high efficiency)

Order options

COLOUR TEMPERATURE

2700 K CRI ≥ 90	9
3000 K CRI ≥ 90	0
3500 K CRI ≥ 90	2
4000 K CRI ≥ 90	1
2700 K CRI ≥ 80	4
3000 K CRI ≥ 80	5
3500 K CRI ≥ 80	7
4000 K CRI ≥ 80	6

CONTROL

DALI-2

LIGHT OPTIC

shelf / floor washer single	W
shelf / floor washer	Y
wallwasher	

MATERIAL COLOUR

chrome reflector	4
black reflector	8

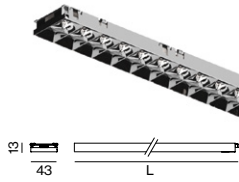

SHELF FLOOR WASHER inset



SHELF / FLOOR WASHER LOW POWER

SYSTEM POWER	COLOUR TEMP.	LUM. FLUX	L (mm)	ORDER CODE
22.1W	3000K	2960lm	1000	0 8 6 - 6 6 1 0 :: 3
	4000K	3370lm		
33.1W	3000K	4440lm	1500	0 8 6 - 6 6 2 0 :: 3
	4000K	5050lm		
42W	3000K	5930lm	2000	0 8 6 - 6 6 3 0 :: 3
	4000K	6740lm		

SHELF / FLOOR WASHER HIGH POWER

SYSTEM POWER	COLOUR TEMP.	LUM. FLUX	L (mm)	ORDER CODE
32W	3000K	4360lm	1000	0 8 6 - 6 6 1 5 :: 3
	4000K	4960lm		
48W	3000K	6540lm	1500	0 8 6 - 6 6 2 5 :: 3
	4000K	7440lm		

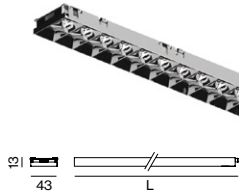

WALLWASHER inset



REFLECTOR WALLWASHER

SYSTEM POWER	COLOUR TEMP.	LUM. FLUX	L (mm)	ORDER CODE
16.5W	3000K	2180lm	1000	0 8 6 - 6 4 1 0 :: 3
	4000K	2490lm		
24.8W	3000K	3280lm	1500	0 8 6 - 6 4 2 0 :: 3
	4000K	3730lm		
33W	3000K	4370lm	2000	0 8 6 - 6 4 3 0 :: 3
	4000K	4980lm		
41W	3000K	5460lm	2500	0 8 6 - 6 4 4 0 :: 3
	4000K	5220lm		
47W	3000K	6550lm	3000	0 8 6 - 6 4 5 0 :: 3
	4000K	7470lm		

Quickinfo

3000 K, 3500 K, 4000 K
 CRI \geq 80, CRI \geq 90, 3 SDCM
 UGR \leq 19
 up to 192 lm/W
 up to 2940 lm/m
 L90 @ 50 000 h
 DALI-2

Types

lens

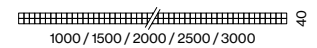
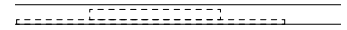

Colour



Light distribution



wide
flood



LENS

linear inset

EN Linear light inset made of plastic; light inset, incl. high power adapter + converter can be installed flexibly and without tools; flush with profile system; equipped with specially computed wide beam lenses; precise radiation characteristic with symmetrical light distribution; for use in schools and offices; energy-efficient LEDs with very good colour rendering

DE Linear-Lichteinsatz aus Kunststoff; Lichteinsatz, inkl. High Power Adapter + Konverter, werkzeuglos einsetz- und verschiebbar; bündig im Profilsystem; bestückt mit speziell berechneten wide beam Linsen; präzise Abstrahlcharakteristik mit symmetrischer Lichtverteilung; für den Einsatz in Schulen und im Bürobereich; energieeffiziente LEDs mit sehr guter Farbwiedergabe



DIN EN 12464-1
UGR \leq 19



up to 192 lm/W
(high efficiency)

Order options

COLOUR TEMPERATURE ⚡

3000 K CRI ≥ 90	0
3500 K CRI ≥ 90	2
4000 K CRI ≥ 90	1
3000 K CRI ≥ 80	5
3500 K CRI ≥ 80	7
4000 K CRI ≥ 80	6

CONTROL

DALI-2

LIGHT OPTIC

wide flood 68°

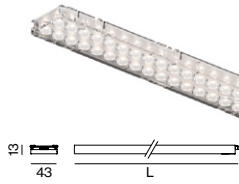

LENS inset



LENS WIDE

SYSTEM POWER	COLOUR TEMP.	LUM. FLUX	L (mm)	ORDER CODE
16.6W	3000K	2590lm	1000	0 8 6 - 6 7 1 0 ⚡ 30 W
	3500K	2770lm		
	4000K	2940lm		
24.8W	3000K	3880lm	1500	0 8 6 - 6 7 2 0 ⚡ 30 W
	3500K	4150lm		
	4000K	4420lm		
32W	3000K	5170lm	2000	0 8 6 - 6 7 3 0 ⚡ 30 W
	3500K	5530lm		
	4000K	5890lm		
40W	3000K	6470lm	2500	0 8 6 - 6 7 4 0 ⚡ 30 W
	3500K	6910lm		
	4000K	7360lm		
46W	3000K	7760lm	3000	0 8 6 - 6 7 5 0 ⚡ 30 W
	3500K	8300lm		
	4000K	8830lm		

Quickinfo

2700 K, 3000 K, 3500 K, 4000 K
 CRI ≥ 80, CRI ≥ 90, 3 SDCM
 up to 163 lm/W
 up to 2590 lm/m
 L90 @ 50 000 h
 DALI-2

Types

lens wallwasher

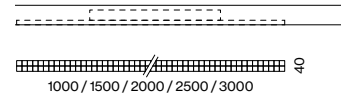

Colour



Light distribution



wall
wash.



LENS

linear inset

EN Linear light inset made of plastic; light inset, incl. high power adapter + converter can be installed flexibly and without tools; flush with profile system; equipped with specially computed wallwasher lenses; precise radiation characteristic with asymmetrical light distribution; energy-efficient LEDs with very good colour rendering

DE Linear-Lichteinsatz aus Kunststoff; Lichteinsatz, inkl. High Power Adapter + Konverter, werkzeuglos einsetz- und verschiebbar; bündig im Profilsystem; bestückt mit speziell berechneten wallwasher Linsen; präzise Abstrahlcharakteristik mit asymmetrischer Lichtverteilung; energieeffiziente LEDs mit sehr guter Farbwiedergabe



up to 190 lm/W
(high efficiency)

Order options

COLOUR TEMPERATURE

2700 K CRI ≥ 90	9
3000 K CRI ≥ 90	0
3500 K CRI ≥ 90	2
4000 K CRI ≥ 90	1
2700 K CRI ≥ 80	4
3000 K CRI ≥ 80	5
3500 K CRI ≥ 80	7
4000 K CRI ≥ 80	6

CONTROL

DALI-2

LIGHT OPTIC



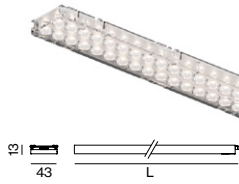

wallwasher



LENS inset



LENS WALLWASHER

SYSTEM POWER	COLOUR TEMP.	LUM. FLUX	L (mm)	ORDER CODE
16.4W	3000K	2270lm	1000	0 8 6 - 6 7 1 0  30 A
24.6W	4000K	2590lm	1500	0 8 6 - 6 7 2 0  30 A
	3000K	3330lm		
32.8W	4000K	3790lm	2000	0 8 6 - 6 7 3 0  30 A
	3000K	4440lm		
41W	4000K	5050lm	2500	0 8 6 - 6 7 4 0  30 A
	3000K	5550lm		
46W	4000K	6310lm	3000	0 8 6 - 6 7 5 0  30 A
	3000K	6650lm		
	4000K	7580lm		

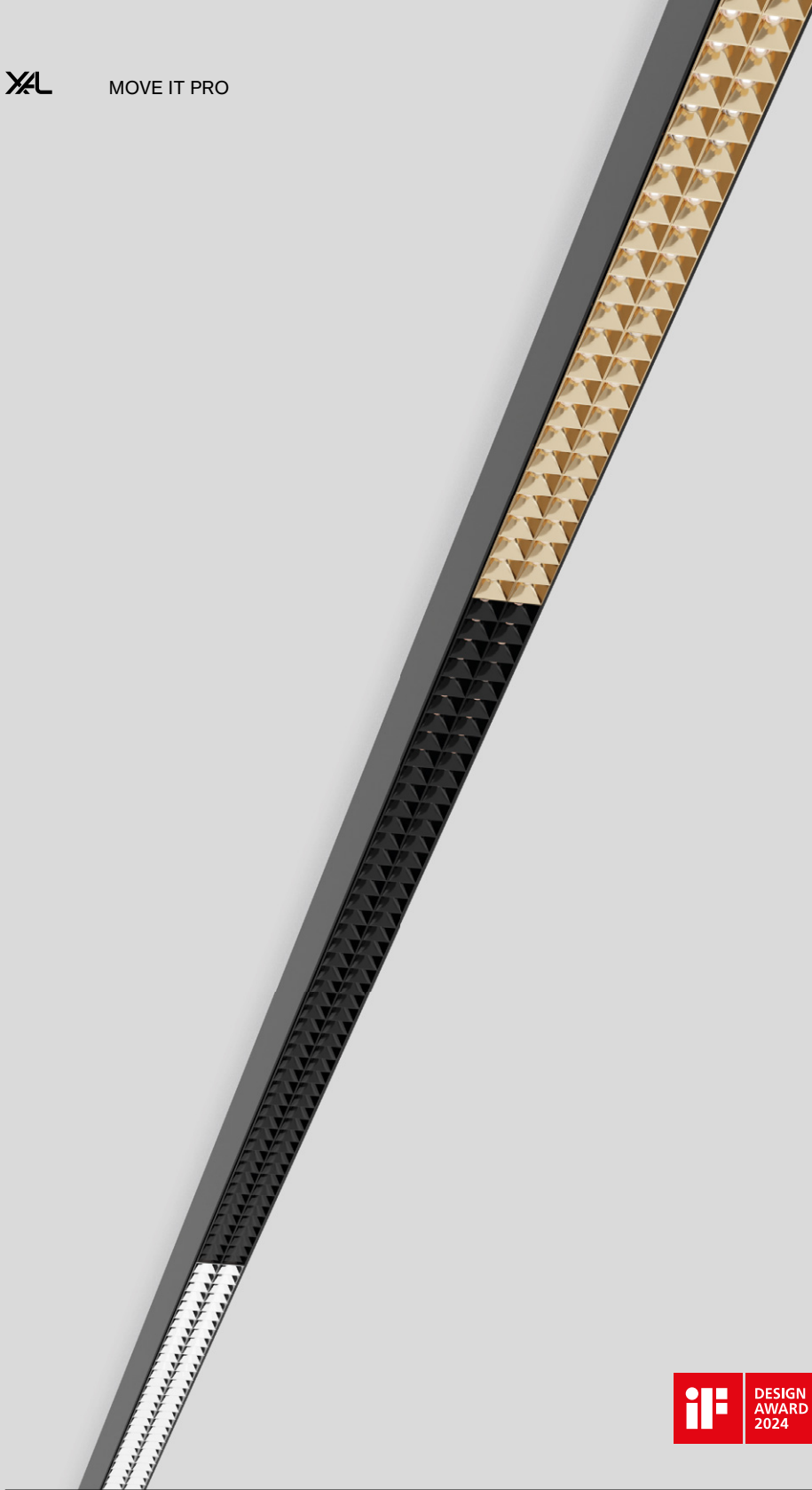

SPOT LINE

linear inset

EN Linear light inset made of plastic; light inset, incl. high power adapter + converter can be installed flexibly and without tools; flush with profile system; fitted with single LED light points; good glare reduction due to recessed light point plane; despite this increased efficiency through special lens technology; inserted lenses with medium or wide flood radiation characteristic; for use in schools, retail and offices; energy-efficient LEDs with very good colour rendering

DE Linear-Lichteinsatz aus Kunststoff; Lichteinsatz, inkl. High Power Adapter + Konverter, werkzeuglos einsetz- und verschiebbar; bündig im Profilsystem; bestückt mit LED Einzellichtpunkten; gute Entblendung durch zurückversetzte Lichtpunktebene; trotzdem erhöhte Effizienz durch spezielle Linsentechnik; eingesetzte Linsen mit medium oder wide flood Strahlungscharakteristik; für den Einsatz in Schulen, Retail- und im Bürobereich; energieeffiziente LEDs mit sehr guter Farbwiedergabe

Quickinfo

2700 K, 3000 K, 3500 K, 4000 K
 CRI ≥ 80, CRI ≥ 90, 3 SDCM
 UGR ≤ 16, 19 / 65° ≤ 1500 cd/m²
 up to 179 lm/W
 up to 2800 lm/m
 L90 @ 50 000 h
 DALI-2

Types

spot line

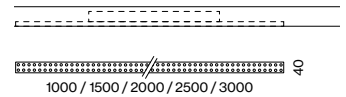

Colours



Light distributions

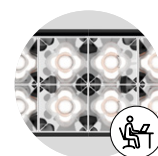

DIN EN 12464-1
 UGR ≤ 16



up to 179 lm/W
 (high efficiency)

Order options

COLOUR TEMPERATURE

2700K CRI ≥ 90	9
3000K CRI ≥ 90	0
3500K CRI ≥ 90	2
4000K CRI ≥ 90	1
2700K CRI ≥ 80	4
3000K CRI ≥ 80	5
3500K CRI ≥ 80	7
4000K CRI ≥ 80	6



CONTROL

DALI-2

LIGHT OPTIC

medium 28°	M
wide flood 67°	W

MATERIAL COLOUR



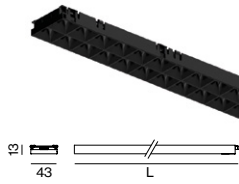

 traffic white RAL 9016	7
 jet black RAL 9005	8
 gold	9



SPOT LINE inset



SPOT LINE

SYSTEM POWER	COLOUR TEMP.	LUM. FLUX	L (mm)	ORDER CODE
16.7W	2700K	2460lm	1000	0 8 6 - 6 3 1 0 :: 3 
	3000K	2460lm		
	3500K	2630lm		
	4000K	2800lm		
25.1W	2700K	3700lm	1500	0 8 6 - 6 3 2 0 :: 3 
	3000K	3700lm		
	3500K	3950lm		
	4000K	4210lm		
33W	2700K	4930lm	2000	0 8 6 - 6 3 3 0 :: 3 
	3000K	4930lm		
	3500K	5270lm		
	4000K	5610lm		
41W	2700K	6160lm	2500	0 8 6 - 6 3 4 0 :: 3 
	3000K	6160lm		
	3500K	6580lm		
	4000K	7010lm		
47W	2700K	7390lm	3000	0 8 6 - 6 3 5 0 :: 3 
	3000K	7390lm		
	3500K	7900lm		
	4000K	8410lm		

Quickinfo

2700 K, 3000 K, 3500 K, 4000 K
 CRI ≥ 80, CRI ≥ 90, 3 SDCM
 up to 150 lm/W
 up to 2350 lm/m
 L90 @ 50000h
 DALI-2

Types

opal

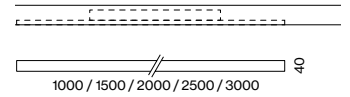
**Colours****Light distribution**

opal

**OPAL**

linear inset

EN Linear light inset made of plastic; light inset, incl. high power adapter + converter can be installed flexibly and without tools; flush with profile system; equipped with specially computed lenses; homogeneously illuminated, satinised PMMA cover; energy-efficient LEDs with very good colour rendering; energy-efficient LEDs with very good colour rendering

DE Linear-Lichteinsatz aus Kunststoff; Lichteinsatz, inkl. High Power Adapter + Konverter, werkzeuglos einsetz- und verschiebbar; bündig im Profilsystem; bestückt mit speziell berechneten Linsen; homogen ausgeleuchtete, satinierte PMMA-Abdeckung; energieeffiziente LEDs mit sehr guter Farbwiedergabe; energieeffiziente LEDs mit sehr guter Farbwiedergabe

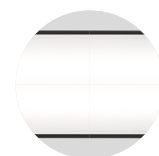
continuous
coverup to 150 lm/W
(high efficiency)

Order options

COLOUR TEMPERATURE

2700 K CRI ≥ 90	9
3000 K CRI ≥ 90	0
3500 K CRI ≥ 90	2
4000 K CRI ≥ 90	1
2700 K CRI ≥ 80	4
3000 K CRI ≥ 80	5
3500 K CRI ≥ 80	7
4000 K CRI ≥ 80	6

CONTROL

DALI-2

LIGHT OPTIC

opal

MATERIAL COLOUR

<input type="radio"/> traffic white RAL 9016	7
<input checked="" type="radio"/> jet black RAL 9005	8
transparent	0

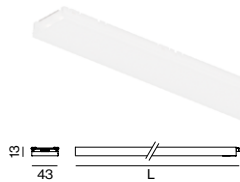
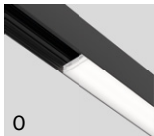
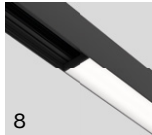

OPAL inset

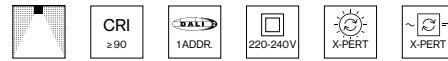

OPAL HIGH PERFORMANCE

SYSTEM POWER	COLOUR TEMP.	LUM. FLUX	L (mm)	ORDER CODE
16.3W	3000K	2060lm	1000	0 8 6 - 6 1 1 0 :: 300
	4000K	2350lm		
24.5W	3000K	3090lm	1500	0 8 6 - 6 1 2 0 :: 300
	4000K	3520lm		
32.7W	3000K	4120lm	2000	0 8 6 - 6 1 3 0 :: 300
	4000K	4700lm		
41W	3000K	5160lm	2500	0 8 6 - 6 1 4 0 :: 300
	4000K	5870lm		
46W	3000K	6190lm	3000	0 8 6 - 6 1 5 0 :: 300
	4000K	7040lm		

Accessories

END CAPS

TYPE	ORDER CODE
end caps pair for opal	0 8 6 - 6 0 9 1 1 1

COVER

TYPE	L (mm)	ORDER CODE
continuous opal cover	6000	0 8 6 - 6 0 8 0 6 0 0 0
continuous opal cover	25000	0 8 6 - 6 0 8 2 5 0 0 0
opal cover	1000	0 8 6 - 6 0 1 0 0 0 0 0
opal cover	1500	0 8 6 - 6 0 2 0 0 0 0 0
opal cover	2000	0 8 6 - 6 0 3 0 0 0 0 0
opal cover	2500	0 8 6 - 6 0 4 0 0 0 0 0
opal cover	3000	0 8 6 - 6 0 5 0 0 0 0 0

Quickinfo

2700 K, 3000 K, 3500 K, 4000 K
 CRI \geq 80, CRI \geq 90, 3 SDCM
 UGR \leq 19
 up to 166 lm/W
 up to 2570 lm/m
 L90 @ 50 000 h
 DALI-2

Types

microprismatic

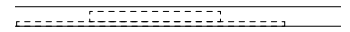

Colours



Light distribution



micropr.



MICROPRISMATIC

linear inset

EN Linear light inset made of plastic; light inset, incl. high power adapter + converter can be installed flexibly and without tools; flush with profile system; completely homogeneously illuminated, microprismatic PMMA cover; for use in offices; energy-efficient LEDs with very good colour rendering

DE Linear-Lichteinsatz aus Kunststoff; Lichteinsatz, inkl. High Power Adapter + Konverter, werkzeuglos einsetz- und verschiebbar; bündig im Profilsystem; absolut homogen ausgeleuchtete, mikroprismatische PMMA-Abdeckung; für den Einsatz im Bürobereich; energieeffiziente LEDs mit sehr guter Farbwiedergabe

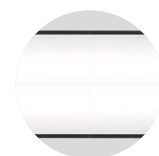

continuous
cover



up to 166 lm/W
(high efficiency)

Order options

COLOUR TEMPERATURE

2700 K CRI ≥ 90	9
3000 K CRI ≥ 90	0
3500 K CRI ≥ 90	2
4000 K CRI ≥ 90	1
2700 K CRI ≥ 80	4
3000 K CRI ≥ 80	5
3500 K CRI ≥ 80	7
4000 K CRI ≥ 80	6

CONTROL

DALI-2

LIGHT OPTIC

microprismatic

MATERIAL COLOUR

<input type="radio"/> traffic white RAL 9016	7
<input checked="" type="radio"/> jet black RAL 9005	8
transparent	0

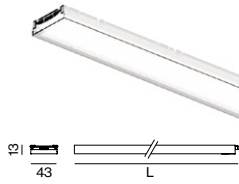
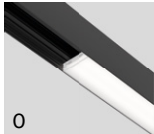
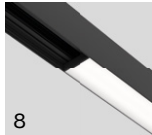

MICROPRISMATIC inset



MICROPRISMATIC

SYSTEM POWER	COLOUR TEMP.	LUM. FLUX	L (mm)	ORDER CODE
16.3W	3000K	2250lm	1000	0 8 6 - 6 2 1 0 :: 30 P
	4000K	2570lm		
24.5W	3000K	3380lm	1500	0 8 6 - 6 2 2 0 :: 30 P
	4000K	3850lm		
32.7W	3000K	4510lm	2000	0 8 6 - 6 2 3 0 :: 30 P
	4000K	5130lm		
41W	3000K	5630lm	2500	0 8 6 - 6 2 4 0 :: 30 P
	4000K	6420lm		
46W	3000K	6760lm	3000	0 8 6 - 6 2 5 0 :: 30 P
	4000K	7700lm		

Accessories

END CAPS

TYPE	ORDER CODE
end caps pair for microprismatic	0 8 6 - 6 0 9 1 2 1

COVER

TYPE	L (mm)	ORDER CODE
continuous microprismatic cover	6000	0 8 6 - 6 0 8 0 6 0 0 P
continuous microprismatic cover	25000	0 8 6 - 6 0 8 2 5 0 0 P
microprismatic cover	1000	0 8 6 - 6 0 1 0 0 0 0 P
microprismatic cover	1500	0 8 6 - 6 0 2 0 0 0 0 P
microprismatic cover	2000	0 8 6 - 6 0 3 0 0 0 0 P
microprismatic cover	2500	0 8 6 - 6 0 4 0 0 0 0 P
microprismatic cover	3000	0 8 6 - 6 0 5 0 0 0 0 P

Quickinfo

3000 K, 4000 K
 CRI ≥ 80, 3 SDCM
 up to 162 lm/W
 up to 3380 lm/m
 non DIM, DALI-2

Types

indirect

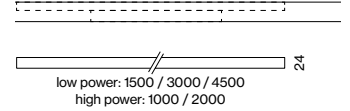
**Colour****Light distribution**

indirect

**INDIRECT**

linear inset

EN Linear light inset made of plastic; light inset, incl. high power adapter + converter can be installed flexibly and without tools; flush with profile system; with indirect light component for additional accentuation of the ceiling; high quality lens system for maximum, homogeneous ceiling illumination; energy-efficient LEDs with very good colour rendering

DE Linear-Lichteinsatz aus Kunststoff; Lichteinsatz, inkl. High Power Adapter + Konverter, werkzeuglos einsetz- und verschiebbar; bündig im Profilsystem; mit indirekter Lichtkomponente für zusätzliche Akzentuierung der Decke; hochwertige Linsenoptik für maximale, homogene Deckenaufhellung; energieeffiziente LEDs mit sehr guter Farbwiedergabe

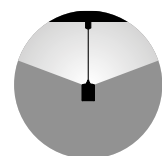

170° indirect
 illumination

Order options

COLOUR TEMPERATURE	
2700 K CRI ≥ 80	4
3000 K CRI ≥ 80	5
3500 K CRI ≥ 80	7
4000 K CRI ≥ 80	6

CONTROL
 DALI-2

LIGHT OPTIC
 batwing

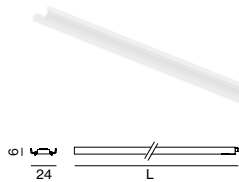

INDIRECT inset



INDIRECT BATWING LOW POWER

SYSTEM POWER	COLOUR TEMP.	LUM. FLUX	L (mm)	ORDER CODE
16.6W	2700K	2240lm	1500	0 8 6 - 6 8 2 0 :: 30 B
	3000K	2240lm		
	3500K	2400lm		
	4000K	2550lm		
32W	2700K	4480lm	3000	0 8 6 - 6 8 5 0 :: 30 B
	3000K	4480lm		
	3500K	4790lm		
	4000K	5100lm		
47W	2700K	6720lm	4500	0 8 6 - 6 8 8 0 :: 30 B
	3000K	6720lm		
	3500K	7190lm		
	4000K	7650lm		

INDIRECT BATWING HIGH POWER

SYSTEM POWER	COLOUR TEMP.	LUM. FLUX	L (mm)	ORDER CODE
22.2W	2700K	2990lm	1000	0 8 6 - 6 8 1 5 :: 30 B
	3000K	2990lm		
	3500K	3190lm		
	4000K	3400lm		
43W	2700K	5980lm	2000	0 8 6 - 6 8 3 5 :: 30 B
	3000K	5980lm		
	3500K	6390lm		
	4000K	6800lm		

Accessories

INDIRECT EXTENSION

SYSTEM POWER	COLOUR TEMP.	LUM. FLUX	L (mm)	ORDER CODE
2.6W low power	2700K	374lm	250	0 8 6 - 6 8 0 0 :: 30 B
	3000K	374lm		
	3500K	399lm		
	4000K	425lm		
5.4W high power	2700K	747lm	250	0 8 6 - 6 8 0 5 :: 30 B
	3000K	747lm		
	3500K	799lm		
	4000K	850lm		

max. inset length per driver: low power 4500mm, high power 2000mm
 without power supply

Example for extension

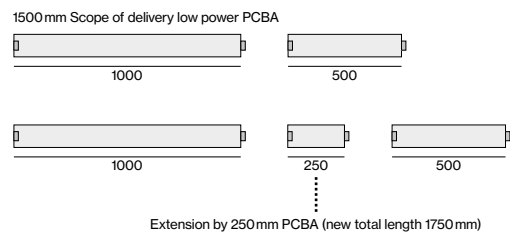

Quickinfo

sensor
 ESSENTIAL, SENSE
 DALI-2

Type

sensor



41

Inset colours**Sensors**

essen- sense
 tial

**SENSOR**

inset

^{EN} Sensor inset; choice of ESSENTIAL or SENSE; ESSENTIAL: brightness and presence sensor; SENSE: brightness, presence, temperature, humidity, air quality and noise level sensor; flush with profile system

^{DE} Sensor-Einsatz; wahlweise ESSENTIAL oder SENSE; ESSENTIAL: Helligkeits- und Anwesenheitssensor; SENSE: Helligkeits-, Anwesenheits-, Temperatur-, Luftfeuchtigkeits-, Luftqualitäts- und Lärmpegelsensor; bündig im Profilsystem

Order options

CONTROL

DALI-2

INSET COLOUR

- traffic white RAL 9016 7
- jet black RAL 9005 8



SENSOR inset



ESSENTIAL SENSOR

TYPE
brightness & movement

ORDER CODE
086-521811



SENSE SENSOR

TYPE
brightness, movement, temperature,
sound pressure, humidity, CO₂

ORDER CODE
086-521812