

LIFTO

Benjamin Thut, 1985/2010

- Einfaches Positionieren mittels Gasdruckfeder
- Blendfreies Licht ohne Mehrschattigkeit in LED und Halogen
- Diverse Befestigungsmöglichkeiten
- In 2 Größen erhältlich
- Positionnement simple avec ressort de pression de gaz
- Lumière sans éblouissement ni ombres multiples pour LED et halogène
- Plusieurs fixations possibles
- Disponible en 2 dimensions



LIFTO LED

Tischleuchte Luminaire de table

- Kraftvolles LED Licht mit 800 Lumen
- Patentierte, stufenlose Weisstonmodulation von 3000 – 4000 Kelvin
- Dimmbar
- Durchschnittlicher Energieverbrauch von 5W
- Lumière LED puissante de 800 lumens
- Brevetée, modulation de la blancheur de l'éclairage, de 3000 à 4000 Kelvins
- Variable
- Consommation moyenne de 5W

REDDOT | DESIGN PREIS SCHWEIZ | INTERNATIONAL DESIGN YEARBOOK

Tischleuchte LED Lampe de table LED	Oberfläche Surface	Farbe Gasdruckfeder Coloris ressort à gaz	Ausführung Version	Typ Type	Bestellnummer N°. de commande	CHF incl. MwSt.	CHF excl. MwSt.
	Schwarz Noir	Schwarz Noir	LED 10x 1W	LIFTO-01-LED-SZ	51000103-01-SZ	611.30	566.00
	Chrom Chromé	Schwarz Noir	LED 10x 1W	LIFTO-02-LED-SZ	51000103-02-SZ	643.70	596.00
	Chrom Chromé	Champagner Champagne	LED 10x 1W	LIFTO-02-LED-CP	51000103-02-CP	643.70	596.00
	Chrom Chromé	Kobaltblau Bleu de cobalt	LED 10x 1W	LIFTO-02-LED-BL	51000103-02-BL	643.70	596.00
	Chrom Chromé	Kiwi Kiwi	LED 10x 1W	LIFTO-02-LED-KW	51000103-02-KW	643.70	596.00

Für Netzspannungen von 90 – 264V, 50/60Hz
Befestigung separat bestellen
Pour tension réseau de 90 – 264V, 50/60Hz
Fixations à commander séparément

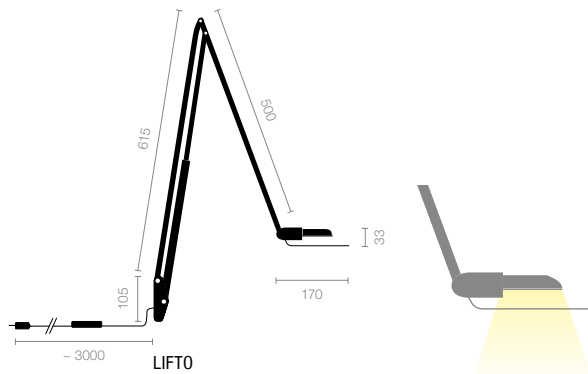

Betriebsgerät, 90 – 264V, 50/60Hz
Appareillage, 90 – 264V, 50/60Hz

INFO belux.com/lifto

FILM belux.com/liftofilm

IP20 CE

LIFTOLINO LED

Tischleuchte Luminaire de table

- Kraftvolles LED Licht mit 800 Lumen
- Patentierte, stufenlose Weissstonmodulation von 3000–4000 Kelvin
- Dimmbar
- Durchschnittlicher Energieverbrauch von 5W
- Lumière LED puissante de 800 lumens
- Brevetée, modulation de la blancheur de l'éclairage, de 3000 à 4000 Kelvins
- Variable
- Consommation moyenne de 5W

REDDOT | DESIGN PREIS SCHWEIZ | INTERNATIONAL DESIGN YEARBOOK

Tischleuchte LED Lampe de table LED	Farbe Arm Coloris du bras	Farbe Gasdruckfeder Coloris ressort à gaz	Ausführung Version	Typ Type	Bestellnummer N°. de commande	CHF incl. MwSt	CHF excl. MwSt
	Chrom Chromé	Schwarz Noir	● LED 10x 1W	LIFTOLINO-03-LED-SZ	51000104-03-SZ	643.70	596.00

Für Netzspannungen von 90–264V, 50/60Hz
Befestigung separat bestellen
Pour tension réseau de 90–264V, 50/60Hz
Fixations à commander séparément

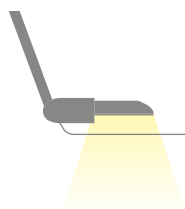
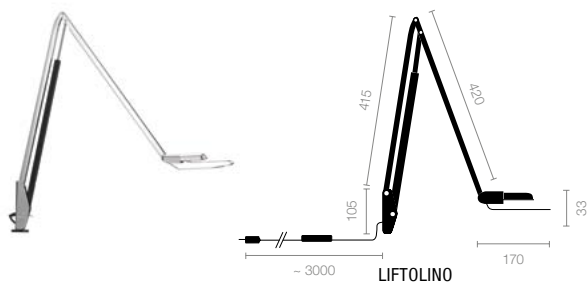

Betriebsgerät, 90–264V, 50/60Hz
Appareillage, 90–264V, 50/60Hz



Weisston: 3000 Kelvin, warm weiss (ww)
Blancheur: 3000 Kelvin, blanc chaud (ww)

Weisston: 4000 Kelvin, neutral weiss (nw)
Blancheur: 4000 Kelvin, blanc neutre (nw)

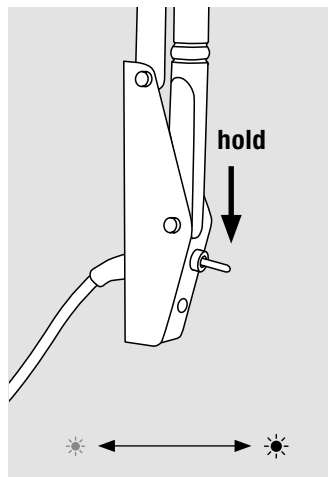
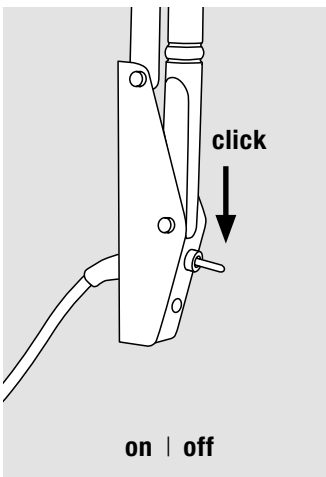

Stufenlos dimmen
Intensité de la lumière réglable en continu

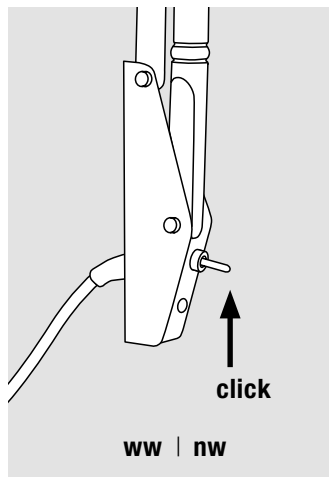

Weisston wechseln
Changement de couleur blanche

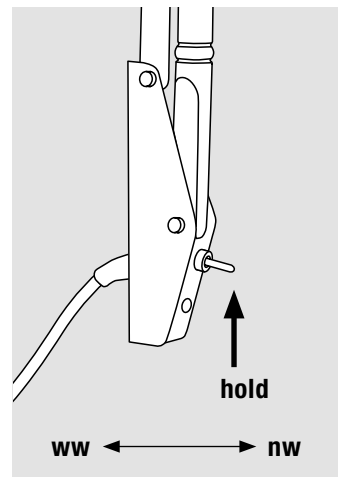



Weisston stufenlos modelieren
Blancheur réglable en continu

LIFTO HALOGEN

Tischleuchte Luminaire de table

- Mit Niedervolt-Halogenlampe
- Mittels Lifetime-Management Lampenlebensdauer von 4000h
- On/Off Schalter im Gehäuse integriert
- Avec lampe halogène basse tension
- Durée de vie de la lampe de 4000 heures grâce à la gestion « lifetime »
- Interrupteur on-off intégré dans le boîtier

REDDOT | DESIGN PREIS SCHWEIZ | INTERNATIONAL DESIGN YEARBOOK

Tischleuchte Halogen Lampe de table halogène	Oberfläche Surface		Typ Type	Leuchtmittel Source	Bestellnummer N°. de commande	CHF incl. MwSt	CHF excl. MwSt
	Schwarz Noir	ON/OFF	LIFTO-01	① incl.	51000100-01	577.80	535.00
	Chrom Chromé	ON/OFF	LIFTO-02	① incl.	51000100-02	604.80	560.00
	Chrom Chromé	ON/OFF	LIFTOLINO-03	① incl.	51000101-03	604.80	560.00

Für Netzspannungen von 90–264V, 50/60Hz
Befestigung separat bestellen
Pour tension réseau de 90 – 264V, 50/60Hz
Fixations à commander séparément

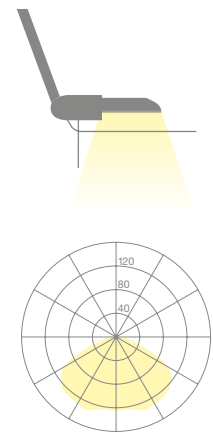
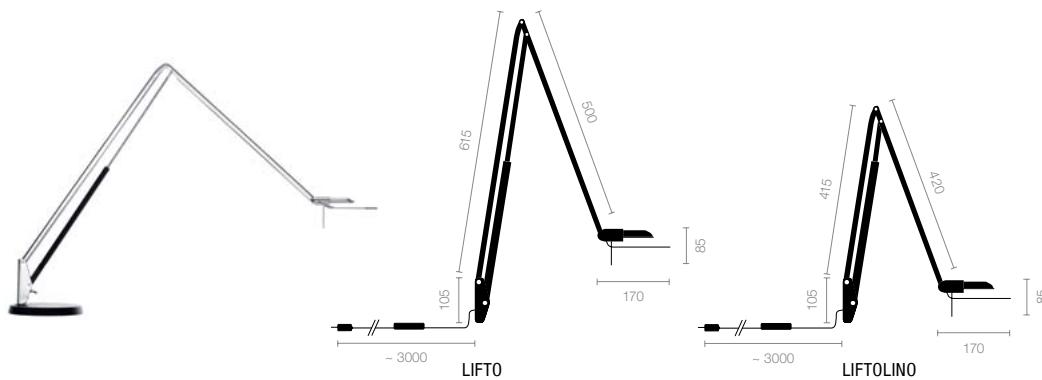

$\eta = 56.22\% \text{ cd}/1000 \text{ lm}$



Betriebsgerät, 90–264V, 50/60Hz
Appareillage, 90 – 264V, 50/60Hz

INFO belux.com/lifto

FILM belux.com/liftofilm

IP20 CE

Leuchtmittel Source		W	V	Fassung Douille	Lumen	Bestellnummer N°. de commande	CHF incl. MwSt	CHF excl. MwSt	
① Halogen ES		C	35W (Δ 50W)	12V	GY 6.35	900	59015800	12.95	12.00

Befestigungen Seite 59
Fixations, voir page 59

LIFTO

Befestigungen Fixations

Befestigungen Fixations	Typ Type	Gewicht Poid	Bestellnummer N°. de commande	CHF incl. MwSt	CHF excl. MwSt
Tischzwinge schwarz Etau de table, noir	FIX-A	0,5 kg	51900401	84.25	78.00
Rundfuss schwarz Base ronde, noir	FIX-B	4 kg	51900101	86.40	80.00
Fixe Befestigung Support fixe	FIX-D		51900601	16.20	15.00
Tischbefestigung zu USM-Haller Bürotisch Support pour système bureau USM Haller	FIX-E (nicht geeignet für höhenverstellbare Ausführung) (ne convient pas pour la version réglable en hauteur)		51900701	21.60	20.00
Befestigung zu USM-Kugelverbinder Support pour USM Haller	FIX-F		51900801	21.60	20.00
Wandbefestigung schwarz Fixation murale noire	FIX-Z-SZ		51902501	75.60	70.00
Wandbefestigung chrom Fixation murale chromée	FIX-Z-CR		51902502	81.00	75.00

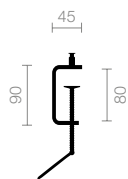

FIX-A
Tischzwinge
Etau de table



FIX-B
Rundfuss
Base ronde



FIX-D



FIX-E



FIX-F



FIX-Z

